

## T9275A Electronic Temperature Controller

### PRODUCT DATA



### APPLICATION

This standalone microprocessor based LCD temperature controller provides proportional plus integral (P+I) and on/off temperature control for commercial Heating, Ventilating and Air Conditioning systems such as VAV, Hydronic Heating, Air Handling Unit, Heating Exchanger or Condensing Tower.

The T9275A1002 has a modulating analog 2 to 10Vdc or 4 to 20mA output and a 2A on/off output to realize various optional control functions including cool/heat changeover, cool/heat sequence control, emergency interlocking and auto-alarming control.

### TABLE OF CONTENT

SPECIFICATIONS .....	2
ORDERING INFORMATION.....	2
INSTALLATION.....	3
WIRING DIAGRAM .....	4
CONTROL OPERATION .....	8
CONFIGURATION AND SETTINGS.....	9

### FEATURES

- PI (proportional plus integral) control action provides accurate, stable and comfortable temperature control.
- Be able to use with series 70 direct-coupled damper actuator or valve actuators like ML7420, ML7421 or ML7984.
- Big bakclit LCD to display both setting and measured value together features friendly user interface.
- Adjustable Zero Energy Band, On/Off Differential, Proportional Band and Temperature Offset.
- Analog output is manually setting available to be convenient for installation commission
- Optional 2 to 10Vdc or 4 to 20mA and reversible analog output
- Selectable internal and external temperature sensor.
- Match with Honeywell standard NTC20 temperature sensors.
- Wide temperature control range (-20 to 110°C by using external temperature sensor) is suitable for extreme temperature control such as steam and ice water.
- Meet various mounting requirements— direct wall mounting, front panel mounting and standard DIN rail mounting.
- Selectable horizontal or vertical wiring direction.
- Pluggable terminal block allows pre-wiring outside of the controller.
- Concisely designed push button for easy operation
- Compact size and slim design provide elegant and attractive modern style appearance.

## SPECIFICATIONS

**IMPORTANT:** The specifications given in this publication do not include normal manufacturing tolerances. Therefore, this unit may not exactly match the listed specifications. Also, this product is tested and calibrated under closely controlled conditions and some minor differences in performance can be expected if those conditions are changed.

### MODELS:

T9275A provides 4 to 20mA or 2 to 10Vdc Proportional plus Integral modulating control and 4(2)A On/Off control.

**Table 1** – Model Specifications

OS#	Inputs		Outputs	
	Analog	Digital	Analog	Digital
T9275A1002	1	1	1	1

### DIMENSIONS:

See Figure 1.

### MOUNTING:

T9275A1002 temperature controller is fit for following mounting methods:

- Direct wall mounting with standard electrical mounting box.
- Front panel mounting with available installation elements
- DIN rail mounting.

### TERMINALS:

Plug-in screw terminals are suitable for no. 20AWG wire.

### POWER SUPPLY:

AC24V  $\pm$  20%, 50/60Hz, 2VA.

### OPERATING AMBIENT:

0-60°C, 5-95%RH

### ACCURACY:

0.1°C

### SETPOINT RANGE

10-60°C (internal temperature sensor)  
-20-110°C (external temperature sensor)

### REMOTE SENSOR:

NTC20, Maximum 50m cable length (line resistance < 4.5Ω)

### ANALOG OUTPUT:

2 to 10Vdc  
or 4 to 20mA

### DIGITAL OUTPUT:

2A, 24Vac

### IP CODE:

IP30

### OPERATING PARAMETER:

See Table 2 for installer selections.

**Table 2** – Option Settings

Parameter	Selection
Zero Energy Band	1.5 or 3.0°C
On/Off Differential	0 to 3°C (0.5°C step change)
Proportional Band	2 to 19°C (1°C step change)
Offset	-3 to 3°C (0.5°C step change)
Set point Definition	Heating, Cooling, H/C midpoint, Heating/Alarming or Cooling/Alarming
Main Sensor	Remote or Internal

## ORDERING INFORMATION

When purchasing replacement and modernization products from your wholesaler or distributor, refer to the price sheets for complete ordering number.

If you have additional questions, need further information, or would like to comment on our products or services, please write or phone your local Honeywell Environmental Controls Sales Office.

**Fig. 1—Dimension in mm (inches)**

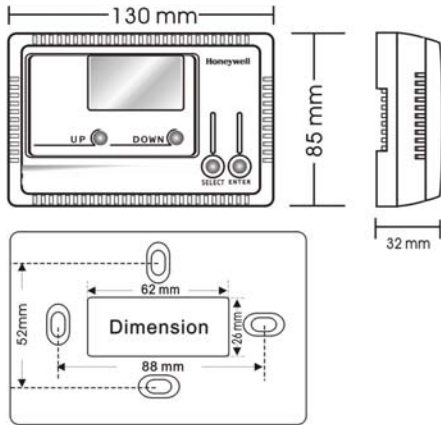

**INSTALLATION**

**Location**

The controller can be installed in any position on a flat surface or DIN rail. To measure room temperature by internal sensor and choosing wall mounting method, it is recommended to be installed 1.5m (about 5 ft.) above the floor in the area at average temperature conditions. For all kinds of mounting method, the product must be installed in an area with good air circulation.

Do not install the controller where it may be affected by:

- Draughts or dead air spots behind doors and in corners.
- Hot or cold air from ducts.
- Radiant heat from sun or appliances.
- Concealed pipes and chimneys
- Unheated (cooled) areas such as an outside wall behind the controller.

**Mounting**

There are 3 possibilities for mounting the controller.

- DIN Rail (see figure 2)

**Fig. 2—DIN rail mounting**

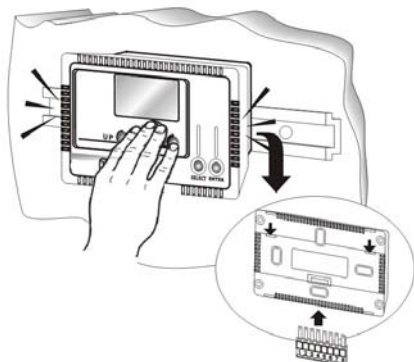

- Wall Mounting with Screws (see figure 3)  
The controller can be directly mounted on the wall or horizontally on either a 65x65mm standard junction box or a 2x4inch US junction box. If choose 65x65mm mounting box, the mounting screw holes must be arrayed vertically.

1. Open the product by a screwdriver.
2. Locate the back cover in the mounting position, insert the mounting screws through the appropriate holes, and screw into position.
3. Complete wiring (see later)
4. Align the fastening hook of back cover with the slots in front cover.
5. Press down the front cover firmly on the back cover.

**Figure 3—Wall Mounting with Screws**

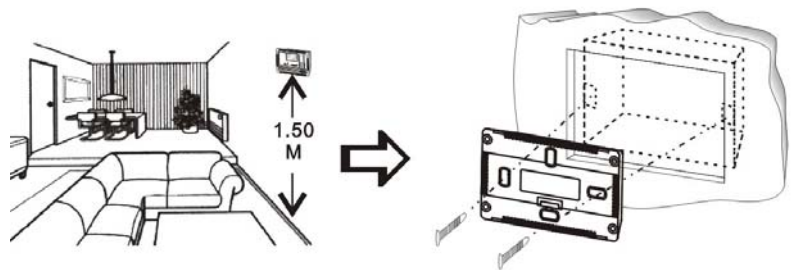

- Panel Front Door Mounting with Screws (see figure 5)

It is required to make a paper-mounting template (see figure 4) to open the mounting hole on the front panel.

1. Paste the mounting plate on the front panel and open the hole according to the size of mounting template.
2. Use a screwdriver to separate the back cover from the front cover. Insert the front cover in the mounting hole.

**Fig 4—Mounting Template**

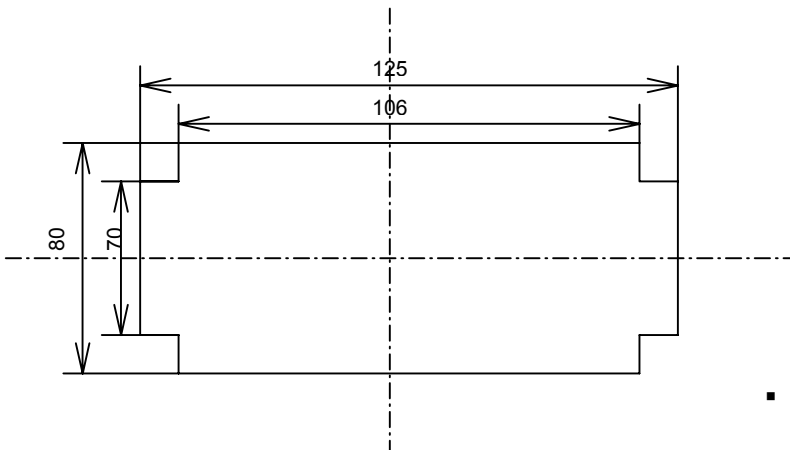

3. Complete the wiring. (See wiring diagram)
4. Insert the back cover in the mounting hole and align the screw holes with the front cover.
5. Insert the screw and fasten it.

**Fig. 5—Panel Front Door Mounting**

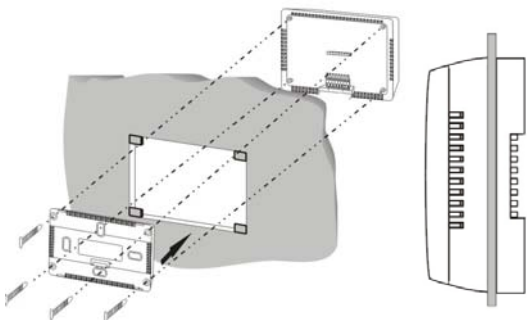

**! WARNING**  
 Disconnect power before installation to prevent electrical shock or equipment damage.

**Wiring Diagram**

- Typical wiring connections are shown in Fig.8 to Fig. 9. The controller uses pluggable wiring terminal block. (Fig 6) Connect the wire with the locking plug firstly according to the sequence number marked on it. Then lock it on the header

block. The special design of terminal can prevent the misconnection between plug and header block. Before wiring you must decide the wiring direction. The default direction is vertical through the hole on the back cover. A vertical direction can be selected if you dismantle the one-off terminal cover at the bottom of the cover. Wiring connections may be made to the screw terminal block with 20AWG, solid or stranded copper wires. Connect the system wires to the controller terminals. Push excess wire back into hole. Plug hole to prevent drafts.

- Auxiliary screw terminal strip may be used in a junction box when the application requires multiple wires to be brought down at the controller, this can make troubleshooting startup and servicing easier.

**Fig 6 – Locking Plug**

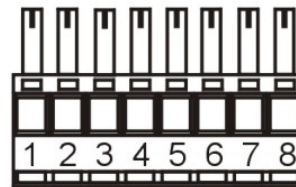

**DIP Switch Settings**

T9275A must be configured for proper operation by setting DIPswitches.

**Figure 7—DIP Switches Setting**

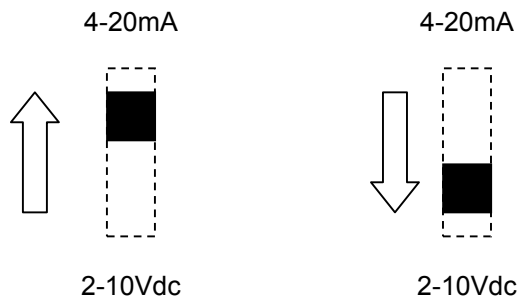

**Single Stage Control--Heat/Cool Changeover**

- I/O List

Output1 Analog 2-10Vdc	Output2 On/Off	Remote Sensor Option	Emergency input
Cooling and / or Heating		✓	✓

Wiring

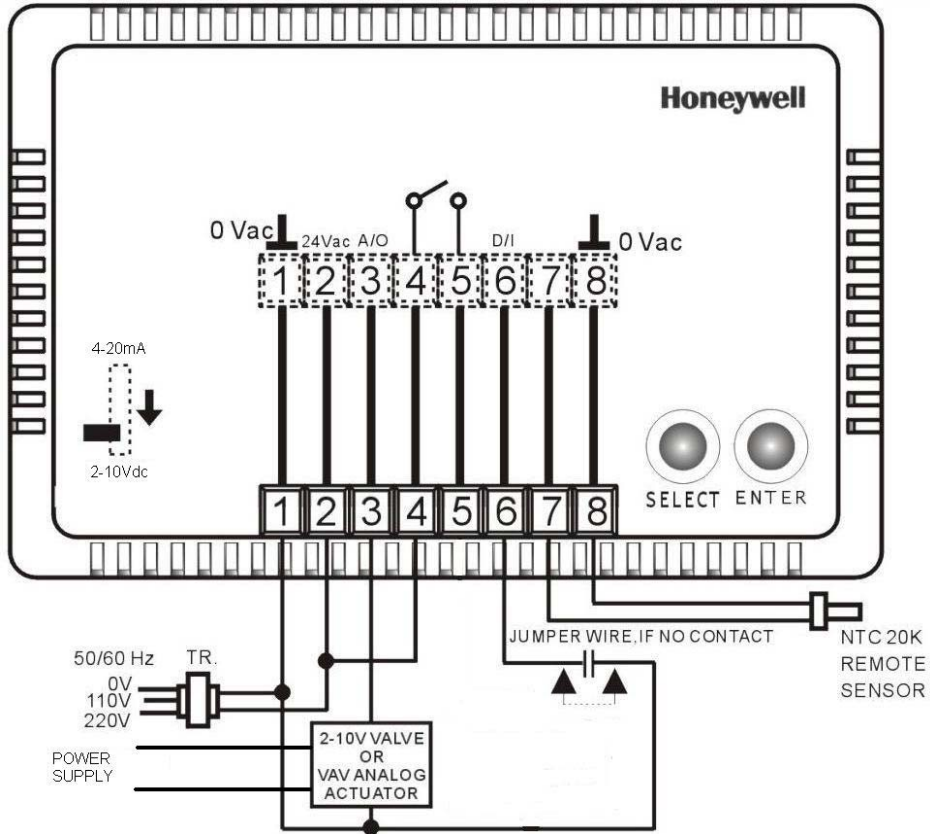

Figure 8

Sequence

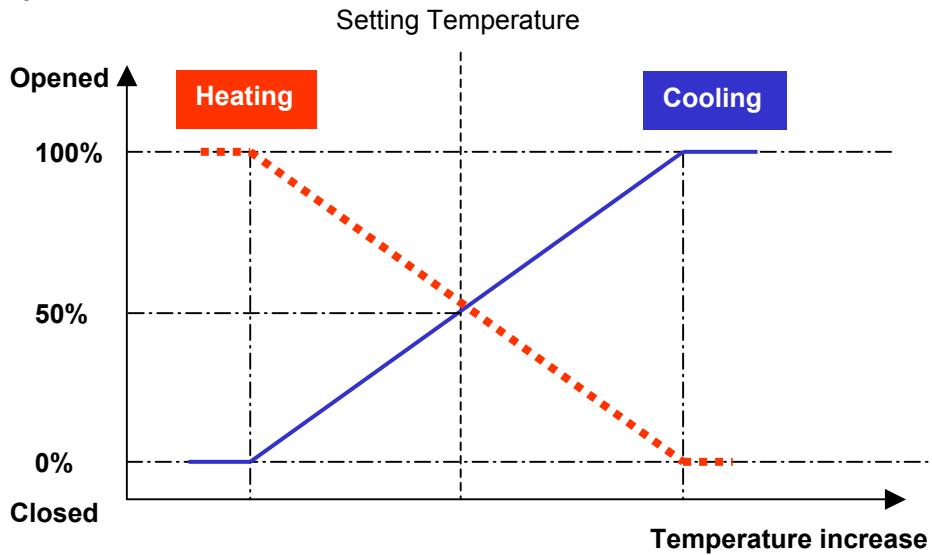

Diagram 1

Heating+Cooling Sequence Control/ H/C+Temperature Limit Control

I/O List

Output1 Analog 2-10Vdc	Output2 On/Off	Remote Sensor Option	Emergency input
Cooling	Heating or Alarm	✓	✓
Heating	Cooling or Alarm		

Wiring

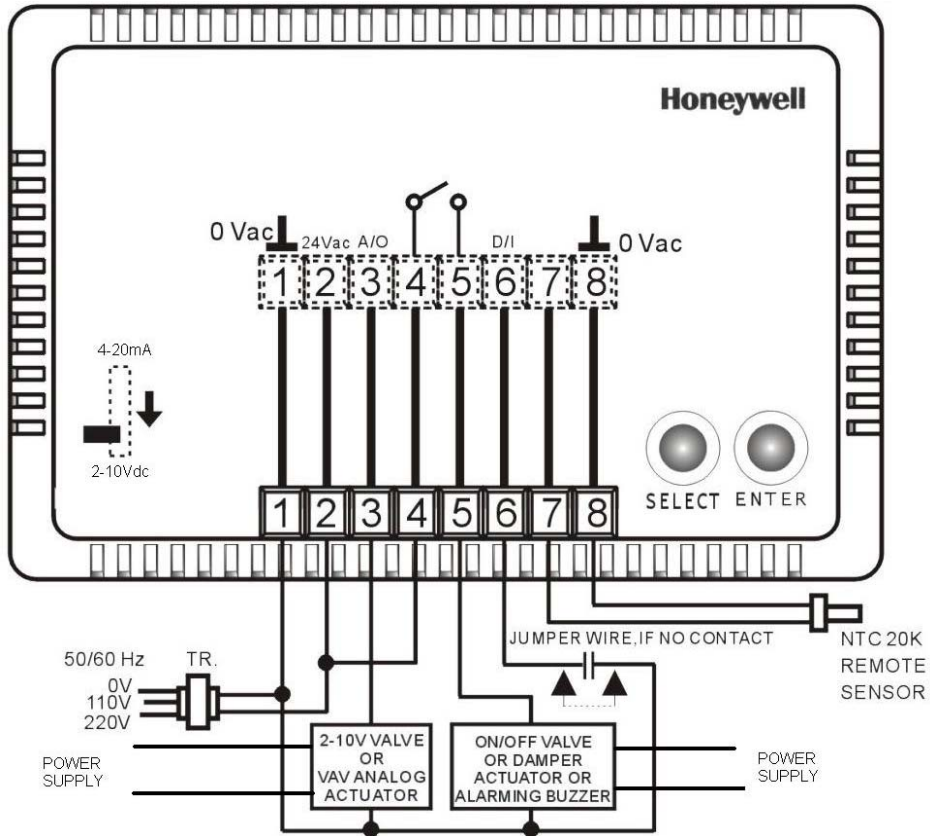

Figure 9

Sequence

Setpoint centered in zero energy band

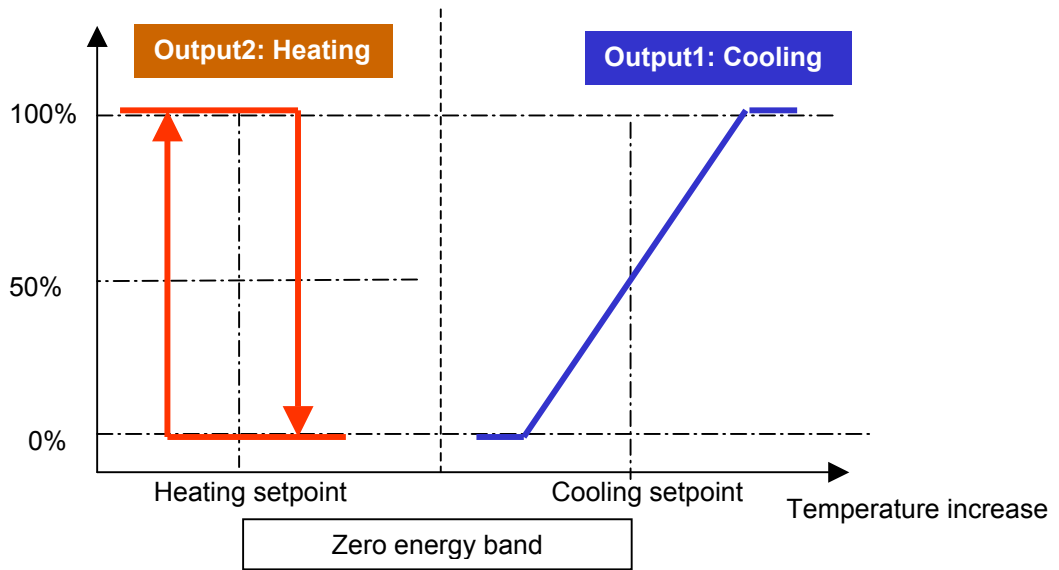

Diagram 2

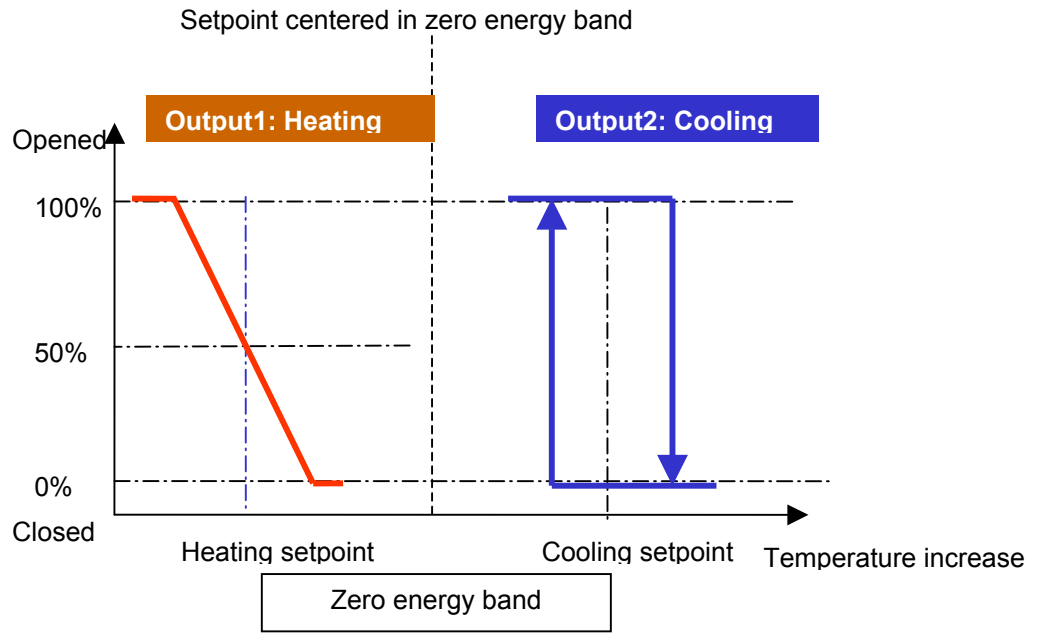

Diagram 3

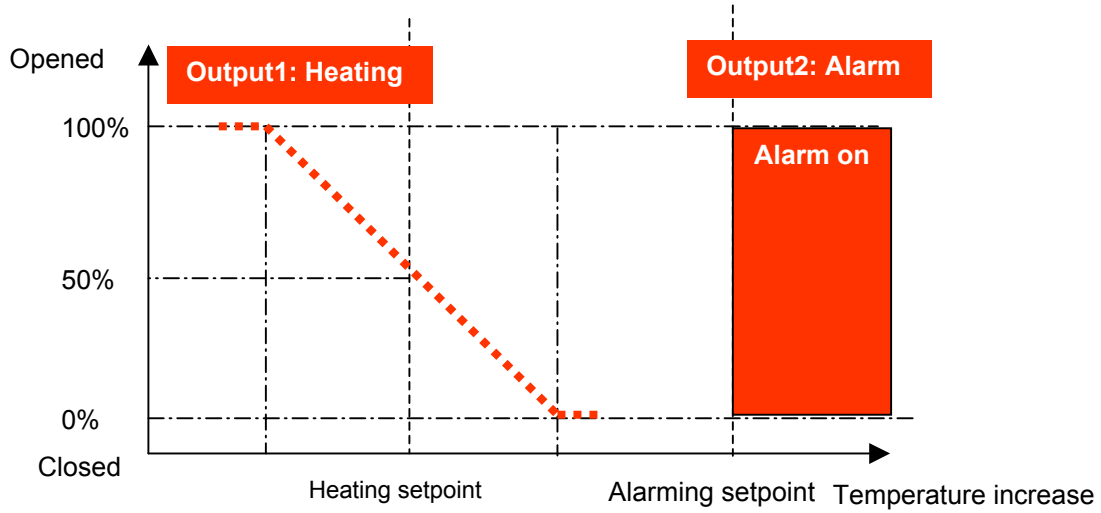

Diagram 4

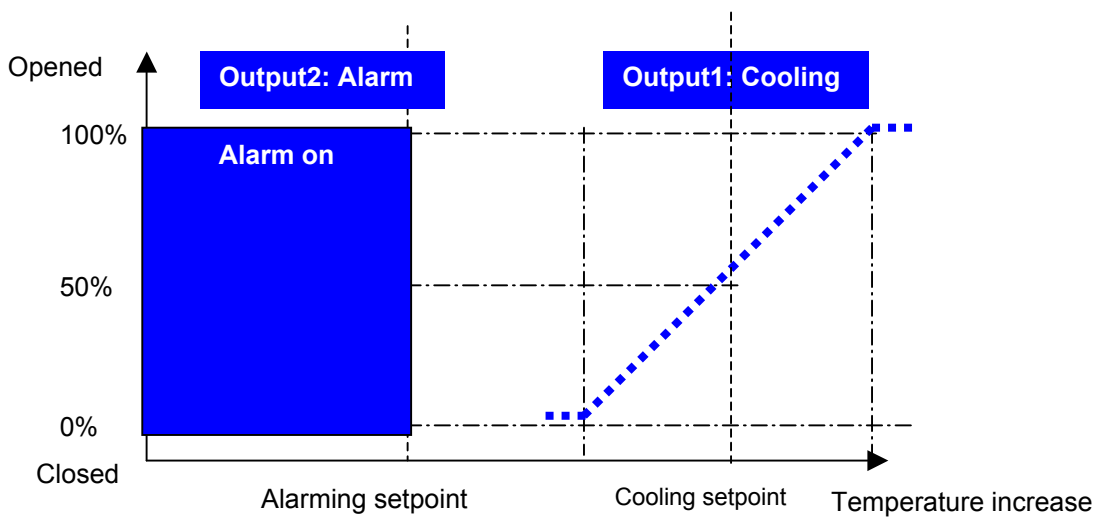

Diagram 5

## Control Operation

### Input1—Temperature Remote Sensor

The controller has an internal sensing device (thermistor) mounted internally. It is also possible to install a remote room or duct return sensor at different locations. See wiring diagram on how to wire the sensor.

**IMPROTANT:** The remote sensor is NTC20—Honeywell popular temperature sensor family. The remote sensor is not enclosed in the controller and must be ordered separately.

### Input2—Emergency Input

Input2 is to connect with an On/Off dry contact for system error or emergency interlock control. If the contact is close, the controller will automatically close all output (or open to the maximum position in reverse mode) and cut off the power. The controller can only be restarted manually.

**IMPORTANT:** If you needn't the interlock function please use a jump wire to connect input2 and neutral port, seen wiring diagram.

### Output1--Modulating Analog Output (2 to 10Vdc or 4 to 20mA)

Output1 is modulating PI analog 2 to 10 Vdc or 4 to 20 mA. It can be selected by DIPswitch.

The output signal is normal mode (2 to 10Vdc or 4 to 20 mA) or reverse mode (10 to 2 Vdc or 20 to 4 mA) selectable.

### Output2—On/Off Digital Output (4(2)A, 24Vac)

Output2 is digital output with 4(2)A, 24Vac nominal capacity. It provides On/Off control for electric heater, on/off valve actuator or fan etc.

Output2 can provide limitation control through pre-setting a separate temperature limitation.

### Heat/Cool Changeover of Output1

Output1 is suitable for Heat/Cool changeover (manually) control in 2 pipes AHU, Zoning control or Hydronic Heating application. The wire connection is shown in **Figure 7**.

With cooling or heating selected the user setpoint will be positioned at the middle of proportional band. The output percentage is proportional to the temperature measured and decided by proportional band. The proportional band can be set from 2<sup>0</sup>C to 19<sup>0</sup>C. The control logic is seen in **Diagram 1**.

### Heating + Cooling Sequence Control with Zero Energy Band

This kind of control requires Zero Energy Band (ZEB) is pre-set. For control purpose, the zero energy band is centred on the user setpoint, so its value defines the effective heating and cooling setpoints.

The cooling setting point will be positioned on the right side of ZEB and the heating setting point is on the left side of ZEB. ZEB can be set as 1.5<sup>0</sup>C or 3<sup>0</sup>C. Any change of set point will cause both heating and cooling sepoints to change in parallel. Either output1 or output2 can be used for cooling or heating control. The control logic is seen in **Diagram 2** and **3**.

### Heating/Cooling + Temperature Limitation Control

Output2 can be used for temperature limitation control. To select this function, 2 temperature setting points must be pre-set. One is in the mid of proportional band of output1 as main setting temperature.

The second one is the temperature limitation of heating or cooling. In this mode if the measured temperature is higher (in heating mode) or lower (in cooling mode) than temperature limitation, output2 will close and output an alarming signal. The control logic is seen in **Diagram 4** and **5**.



## CONFIGURATION AND SETTINGS

All configuration parameters have to be set to select the correct control functions as required for the job application and to start control operation and synchronization of the final control devices.

All default setting values pre-configured by factory are listed in Table 3.

**Table 3** - Default Value List

Setting Parameters	Default Value
ZBAND	1.5 <sup>0</sup> C
DIFF	0 <sup>0</sup> C
PBAND	2.0 <sup>0</sup> C
OFFSET	0 <sup>0</sup> C
MODE	0
REVERSE	0
DISPLAY	0
MANUL	0
ST	30 <sup>0</sup> C
I (F1)	15seconds
ALARM (F2)	30 <sup>0</sup> C





The detail setting process is shown in Table 3.



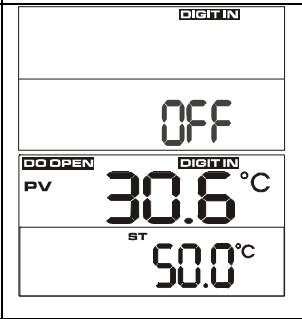
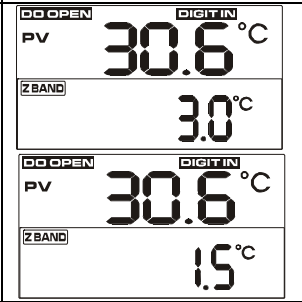
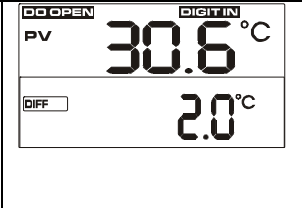

**IMPORTANT:** Before start setting, please check the following items,

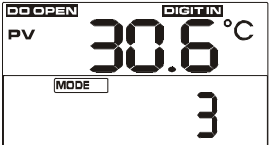
1. Inspect the controller visually and check the push button before connect main power. There should be no any abnormal phenomena or obvious shipping damage.
2. Check the DIPswitch and make sure the switch is set at the right position.

Table 4—Setting &amp; Operation Manual

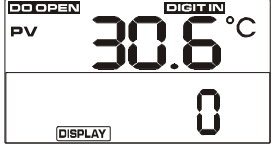
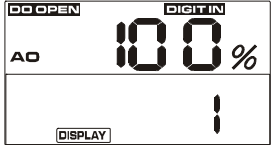
Item	Operation	Display
Power On/Off	<ul style="list-style-type: none"> <li>➤ Connect the main power. Display screen shows “DIGIT IN” and “OFF”.</li> <li>➤ Press the ‘SELECT’ key and hold more than 3 seconds, the controller turns on. It will read the setting value in EPROM automatically. The controller is powered on.</li> <li>➤ After power on, LCD screen displays ambient temperature, output2 shows “DO OPEN”.</li> <li>➤ Press “select” key and hold more than 3 seconds, the product is powered off. And the display shows “OFF”.</li> </ul>	
Temperature Adjustment	<ul style="list-style-type: none"> <li>➤ Press key ▲ one time, the setting temperature will be 1°C up. Press and hold the key more than 2 seconds, the temperature increases continuously until reaches 60°C(internal sensor) or 110°C(remote sensor). Press the button one more time to stop the temperature change.</li> <li>➤ Press the key ▼ one time, setting temperature will be 1°C down. Press it and hold more than 2 seconds, the temperature decreases continuously until reaches 10°C(internal sensor) or -20°C(remote sensor). Press the button one more time, the temperate change stops.</li> </ul>	
ZEB Value Setting	<ul style="list-style-type: none"> <li>➤ Press “SELECT” 1 time to choose “Z BAND”.</li> <li>➤ Press key ▲ 1 time “ST” switches between 1.5°C and 3.0°C.</li> <li>➤ Press key ▼ 1 time “ST” switches between 3.0°C and 1.5°C.</li> <li>➤ Press “ENTER” one time to save the setting value.</li> <li>➤ If no input in 3 seconds, the controller will leave setting mode and return to normal operation mode automatically.</li> </ul>	
Differential Setting	<ul style="list-style-type: none"> <li>➤ Press “SELECT” to choose “DIFF”.</li> <li>➤ Press key ▲ 1 time “ST” is 0.5°C up. The changing range is 0-3°C. The temperature will stop if the value reaches 3°C</li> <li>➤ Press key ▼ 1 time “ST” is 0.5°C down. The changing range is 3-0°C and the temperature will not change if the value reaches 0°C.</li> <li>➤ Press “enter” to save setting value.</li> </ul>	

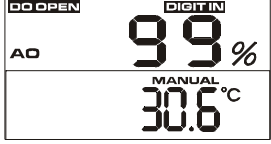
Item	Operation	Display
Proportional Band Setting	<ul style="list-style-type: none"> <li>➤ Press "SELECT" to choose "P BAND".</li> <li>➤ Press key ▲ 1 time "ST" will be 1<sup>0</sup>C up. The range is 2-19<sup>0</sup>C. Hold the key 2 seconds up; the temperature increases continuously until reaches 19<sup>0</sup>C. Press the button again, temperature change stops.</li> <li>➤ Press key ▼ 1 time "ST" will be 1<sup>0</sup>C down. The range is 19-2<sup>0</sup>C. Hold it 2 seconds up, the temperature decreases continuously until reaches 2<sup>0</sup>C. Press the button again, temperature change stops.</li> <li>➤ Press, "ENTER" button to save setting value.</li> </ul>	
Offset Setting	<ul style="list-style-type: none"> <li>➤ Press "SELECT" to choose "OFFSET".</li> <li>➤ Press key ▲ 1 time "ST" will be 0.5c up; the range is from -3 to 3<sup>0</sup>C. Hold the key in 2 seconds; the temperature increases continuously until reaches 3<sup>0</sup>C. Press the button again, temperature change stops.</li> <li>➤ Press key ▼ 1 time, "ST" will be 0.5<sup>0</sup>C down; the range is from 3 to -3<sup>0</sup>C. Hold the key in 2 seconds, the temperature decreases continuously until reaches -3<sup>0</sup>C. Press the button again, temperature change stops.</li> <li>➤ Press, "ENTER" button to save setting value.</li> </ul>	
Mode Setting	<ul style="list-style-type: none"> <li>➤ Press "SELECT" to choose "MODE".</li> <li>➤ Press key ▲ 1 time "ST" will be 1 up, the range is 0-6            0: output1 cooling    output2 no function                    1: output1 heating    output2 no function            2: output1 cooling    output2 heating    3: output1 heating    output2 cooling            4: output1 cooling    output2 low temperature limit    5: output1 heating    output2 high temperature limit            When the value reaches 5, the setting value will not change.</li> <li>➤ Press key ▼ 1 time "ST" will be 1 down until to 0, then no change if continue to press the key.</li> <li>➤ Press, "ENTER" button to save setting value.</li> </ul>	
Sensor Setting	<ul style="list-style-type: none"> <li>➤ Press "SELECT" to choose "SENSOR".</li> <li>➤ Press key ▲ "ST", the value switches between 0 and 1: 0→internal sensor    1→external sensor</li> <li>➤ Press key ▼ "ST", the value switches between 1 and 0</li> <li>➤ Press, "ENTER" button to save setting value.</li> </ul>	

Item	Operation	Display
Reverse Setting	<ul style="list-style-type: none"> <li>➤ Press “SELECT” to choose “REVERSE”.</li> <li>➤ Press key ▲ “ST” value will switch between 0 and 1: 0→ output1 in normal mode, 2—10Vdc or 4-20mA 1→output1 in reversing mode, 10—2Vdc or 20-4mA</li> <li>➤ Press key ▼ “ST” value will switch between 1 and 0.</li> <li>➤ Press, “ENTER” button to save setting value.</li> </ul>	
Display Setting	<ul style="list-style-type: none"> <li>➤ Press “SELECT” to choose “DISPLAY”.</li> <li>➤ Press key ▲ “ST” value will switch between 0 and 1. 0: Normal Mode, output1 is decimal value signal    1: Percentage Mode, output1 is percent value (2Vdc or 4mA--0%    10Vdc or 20mA--100%).</li> <li>➤ Press key ▼ “ST” value will be 1 down.</li> <li>➤ Press, “ENTER” button to save setting value.</li> <li>➤ In percentage mode the screen will show “AO” and “%”.</li> </ul>	 
Manual Setting	<ul style="list-style-type: none"> <li>➤ Press “SELECT” to choose “MANUAL”.</li> <li>➤ Press key ▲ “ST” value switches between 0 and 1: 0→MANUAL OFF    1→MANUAL ON</li> <li>➤ Press key ▼ “ST” value switches between 1 and 0.</li> <li>➤ Press, “ENTER” button to save setting value.</li> <li>➤ If manual on, PV screen will show “AO” and “%”, ST screen shows measured value</li> <li>➤ If manual on, press key ▲ 1 time, the displayed value will be 1% up. Hold the key 2 seconds up; the value increases continuously until reaches 100%.</li> <li>➤ If manual on, press key ▼, the value will be 1% down. Hold the key 2 seconds up; the value decreases continuously until reaches 0%.</li> <li>➤ After 90 minutes manual on operation, the controller will return to manual off mode automatically.</li> </ul>	 
F1 Setting	<ul style="list-style-type: none"> <li>➤ Press key “SELECT” to choose “F1”.</li> <li>➤ Press key ▲ 1 time “ST” value will be 0.1 second up; the range is from 0.1 to 60 seconds. Hold the key 2 seconds up; the value increases 0.1 second until reaches 60.</li> <li>➤ Press the key ▼ everything is reverse.</li> <li>➤ Press “ENTER” to save.</li> <li>➤ This value setting shows how long the output1 will update the output value.</li> </ul>	

Item	Operation	Display
F2 Setting (Temperature Limit)	<ul style="list-style-type: none"> <li>➤ Press "SELECT" to choose "F2".</li> <li>➤ Press key ▲ one time, the setting temperature will be 1<sup>0</sup>C up. Press and hold the key more than 2 seconds, the temperature increases continuously until reaches 60<sup>0</sup>C(internal sensor) or 110<sup>0</sup>C(remote sensor). Press the button one more time to stop the temperature change.</li> <li>➤ Press the key ▼ one time, setting temperature will be 1<sup>0</sup>C down. Press it and hold more than 2 seconds, the temperature decreases continuously until reaches 10<sup>0</sup>C(internal sensor) or -20<sup>0</sup>C(remote sensor). Press the button one more time, the temperate change stops.</li> <li>➤ Press "ENTER" to save the setting value</li> </ul>	
Output2 Description	If output2 has no output signal, the screen shows "DO OPEN" and the resistance value is high. Otherwise the screen shows "DO CLOSE" and the resistance value is low.	

**Honeywell**

---

**Automation and Control Solutions**

Honeywell Pte. Ltd.  
Honeywell Building  
17 Changi Business Park Central 1  
Singapore 486073